

SLH 200

10.04 -

Operating Instructions

GB

50452174

01.08

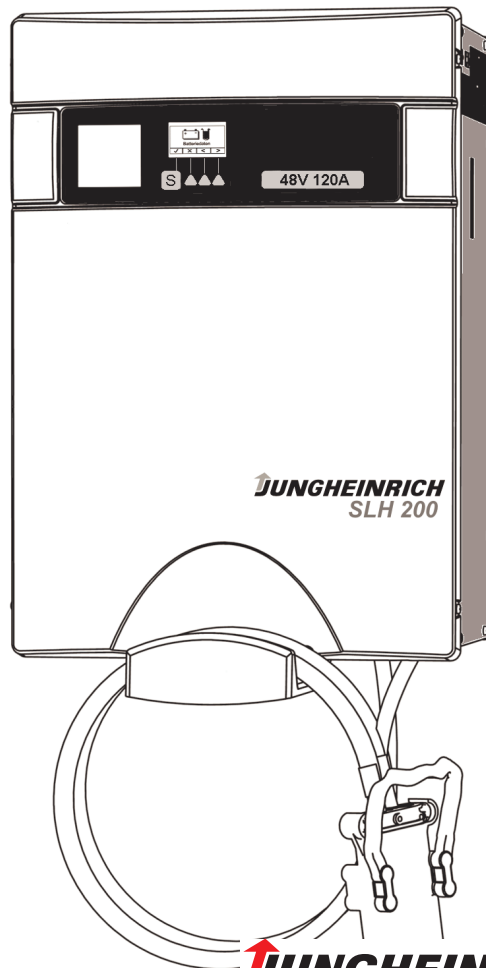

JUNGHEINRICH
Machines. Ideas. Solutions.

Jungheinrich Aktiengesellschaft

Am Stadtrand 35
D-22047 Hamburg-Germany

Tel.: +49 (0) 40/6948-0

www.jungheinrich.com

Index

1	General	4
1.1	Purpose of Operating Instructions	4
2	Safety	4
2.1	General	4
2.2	Decal and Symbol Notices	4
2.3	Personnel Qualification.....	5
	2.3.1 Commercial Use	5
2.4	Correct use and application.....	5
2.5	Assembly and Installation Safety Instructions	6
2.6	Operating Safety Instructions.....	7
2.7	Troubleshooting and Repairs Safety Instructions	7
3	Product Specifications	7
3.1	Product Functional Description.....	7
3.2	Model Description	8
3.3	Accessory Functional Description	8
	3.3.1 Charger	8
3.4	Residual Risk.....	8
3.5	Protective Mechanisms.....	9
3.6	Charger Labelling and Decals.....	10
4	Transport, Handling and Storage	10
5	Assembly / Installation / Commissioning	10
5.1	Delivery scope.....	10
5.2	Site Requirements.....	11
5.3	Mains Connection and Mains Fuses.....	11
5.4	Assembly and Installation.....	12
5.5	Commissioning the charger for the first time and operational testing.....	12
6	Operation	12
6.1	Operating and Display Function.....	13
	6.1.1 Charge Status Light.....	14
	6.1.2 Soft keys	15
	6.1.3 Graphic display and menu structure.....	16
	6.1.4 Adjustable parameters.....	17
	6.1.5 Function – Battery Maintenance.....	17
	6.1.6 Function – Measured values.....	18
	6.1.7 Graphic Display Information.....	18
	6.1.8 Parameters – Consumption data.....	18
	6.1.9 Parameters - Statistics.....	19
6.2	Charger Mains Connection	19
6.3	Battery Connection	19
6.4	Charging automatic start	20
6.5	Interrupting a charge.....	21
6.6	Charging automatic end.....	21
6.7	Readings.....	22
6.8	Status messages.....	23
6.9	Faults and Error Messages	24
6.10	Switching off the charger.....	25
7	Maintenance	25
7.1	Cleaning, Inspection and Maintenance	25
7.2	Changing the charging program.....	26
7.3	Spare parts	26
8	Disposal	26
9	Appendix	27
9.1	Dimension and Projection Drawings (not to scale)	27
9.2	Specifications.....	28
9.3	Model table	28
9.4	Charging programs	29
9.5	Spare parts catalog	30

1 General

1.1 Purpose of Operating Instructions

The aim of the present operating instructions is to ensure the correct and safe operation of the SLH 200 charger. The SLH 200 will hereafter be referred to as the charger.

The operating instructions must always be available and stored in the vicinity of the charger. The operating instructions must be read and applied by anyone involved in operating the charger, including shipping, assembly and installation, operation, maintenance and disassembly work.

For commercial use, the relevant work safety guidelines, standards and regulations of the place or country of operation must be observed alongside the present operating instructions.

For further information beyond the scope of the operating instructions, please consult with the manufacturer's specialist technicians.

All documentation is copyright protected. The transfer or reproduction of documentation, including excerpts, as well as the assessment and dissemination of its content are prohibited unless expressly permitted.

2 Safety

2.1 General

The operating instructions are a major component of the charger.

The owner shall ensure that the operating instructions are permanently in the vicinity of the charger, and that operating personnel shall be notified of these guidelines.

The owner shall add further instructions regarding national accident prevention and environmental protection regulations to the operating instructions, including information on supervisory and reporting obligations, taking into account particular company practices e.g. in terms of work organization, work processes and the personnel employed.

Apart from the operating instructions and the current accident prevention regulations in force in the country and place of use, generally recognised technical regulations for safe and proper use shall be observed.

2.2 Decal and Symbol Notices

This charger has been produced in accordance with generally accepted principles and state-of-the-art technology. To ensure sufficient levels of safety for personnel, additional safety instructions are issued. Sufficient safety when handling the charger is only provided when these instructions are observed.

From time to time it is necessary to emphasize specific instructions. These sections have different meanings:

**Note**

Notes contain additional information to ensure safe and efficient handling of the charger.

**Attention**

This warning indicates possible damage that could be caused by failing to take precautionary measures or improper use. Observe all warnings and measures needed to prevent damage from occurring to the charger and other articles. Be particularly vigilant.

**Danger**

This warning indicates possible damage that could be caused to persons, by failing to take precautionary measures or improper use. Observe all warnings and measures required to prevent injuring yourself or other people. Be particularly vigilant.

2.3 Personnel Qualification

Only qualified technicians should operate the charger. The levels of responsibility for personnel operating and installing/repairing the charger should be clearly separated. Qualified technicians in the sense of these basic instructions are people responsible for assembly, installation, commissioning, operation, maintenance, de-commissioning and disassembly, and who are *suitably qualified to carry out their role*.

The charger may only be installed, commissioned for the first time, repaired and disassembled by qualified and authorized *electrical engineers*.

With trained electrical engineers it is assumed that they will observe and comply with current regulations of the local energy supply company as well as the industry work safety guidelines (e.g. BGV A2) and all regulations governing the safe and proper use of the charger (e.g. DIN VDE 0100 and IEC 60664 or DIN VDE 0110).

The manufacturer does not accept liability for any damage or loss of business arising from the failure to comply with these operating instructions.

2.3.1 Commercial Use

If the charger is used in a commercial environment, the following also applies:

- The operator must undergo special instruction or training on how to charge lead acid accumulators and how to operate them.
- Only authorised personnel may operate the charger.

2.4 Correct use and application

The SLH 200 charger is designed to charge lead acid accumulators. Depending on the preset charging program, only wet cell batteries designed for the charger program or suitably sealed, maintenance-free traction batteries should be charged. The charger is unsuitable for all other accumulators and non-rechargeable batteries.

If required by the owner, the charger can be fitted with a range of different connectors. The owner is therefore obliged,

- only to use connectors with the suitable fuse rating for the charger,
- to avoid connecting unsuitable battery types.

The latter could be achieved for example by colour-coding or mechanically coding the connector.

Always observe and comply with the battery manufacturer's instructions.

If the charger has a charging program which has been modified, the owner is obliged to permanently advise of the suitable battery type on the housing exterior.

To ensure proper use, observe and comply with the details on the location site (see sections 2.5 and 5.2), the data plate and the specifications (see Appendix).

Risk of injury



Serious damage to personnel and property could arise from:

- improper use or incorrect operation,
- unauthorised opening of the charger,
- incorrect installation or improper service or repair work.

All instructions regarding the correct use, residual risk, installation, operation and maintenance contained in these operating instructions must therefore be noted and observed.

The charger must only be used for the purposes foreseen in the present operating instructions and the technical description and only with the accessories or components recommended and approved by the manufacturer.

Any other use beyond the scope of the above is not appropriate. The owner or user of the charger shall be liable for any damage arising from the above.

The charger shall only be commissioned in accordance with electromagnetic compatibility guidelines (89/336/EC).

2.5 Assembly and Installation Safety Instructions

Before installing the charger, check that all the components have been supplied against the delivery notes. If anything is missing, immediately contact the manufacturer.

The place of operation must be weather-proof and dry.

The ambient temperature at the site must not fall below 0°C or exceed 40°C. Avoid the build-up of heat within the charger, e.g. through heat sources or by blocking the air vents.

The location site must be sufficiently ventilated to distribute (reduce) charging gases which may arise (acid fog, electrolytic gas) and prevent the build-up of explosive gas mixtures.

The site must not contain excessive dust. Avoid the occurrence of conductive dust (soot, metal).

No liquid must enter the inside of the charger.

The distance between the charger and inflammable materials must be at least 2.5m horizontally. It is forbidden to store inflammable materials, e.g. in shelves, or to use inflammable materials above the charger. There must be at least a 5.00m gap between fire and explosive-hazardous areas.

The charger must be protected against overload or stress. In particular, no components must be damaged during transport and when being handled. Avoid contact with electronic components.

The charger contains electrostatic endangered components which can easily be damaged through improper handling. Electrical components must not be physically damaged or destroyed.

Electrical installation (wire cross sections, fuses, earth leads) must be performed in accordance with current regulations.

Prior to electrical installation, the performance data on the data plate must be checked against the performance data of the supply connections. The charger must be protected against excessive shock-hazard voltages through a mains fuse connected in series. Observe the mains connection values indicated on the data plate (voltage and frequency).

2.6 Operating Safety Instructions

The charger must only be used when in technically good working order and when used in accordance with the present operating instructions with attention paid to the safety and hazard risks. Any faults that could affect safety must be removed immediately.

The data plate specifications regarding the appropriate battery voltage must be checked and complied with prior to connecting the charger cable. The charger leads must be connected to the correct battery terminals.

When connecting the battery, route the charging leads so that they cannot be tripped over and that charging cannot be interrupted by unplugging the charging lead. If an ongoing charge is interrupted by removing the charging lead, this may produce sparks which could result in fire or explosions.

If the charger or the operating pattern of the charger is changed in a way that could affect safety, shut down the charger and notify the relevant department of the fault.

2.7 Troubleshooting and Repairs Safety Instructions

Contact the manufacturer prior to opening the housing for maintenance and repair purposes.

Prior to carrying out maintenance or repair work, always disconnect the charger from the mains.

After switching off the charger, wait for at least five minutes before opening the panels and housing.

No changes or modifications may be made to the charger which could affect safety without obtaining the manufacturer's approval. This also applies to the assembly and setting of safety mechanisms. In particular make sure that no safety, leakage or air distances are reduced.

Spare parts used must meet the technical requirements specified by the manufacturer. This requirement is always met by original manufacturer's spare parts.

3 Product Specifications

3.1 Product Functional Description

The SLH 200 charger is designed to charge lead acid accumulators. Depending on the preset charging program, wet cell batteries or sealed, maintenance-free traction batteries can be charged.

The charger has an adjustable, high-frequency power part, a micro-processor controlled charging electronics system and a control/display panel with buttons and a charge status light, as well as a graphic enhanced LCD display. The charging program for the respective battery type is factory-set to the customer's requirements.

The various charger assemblies are installed in a secure steel sheet housing with a plastic front panel. The charger is equipped with a mains cable and connector (optional for threephase models) for connection to the mains.

3.2 Model Description

The SLH 200 charger is available in different options. The following is a typical model description (e.g. for a 24 volt, 120 amp charger).

Type E 230 G 24/120 B-SLH200

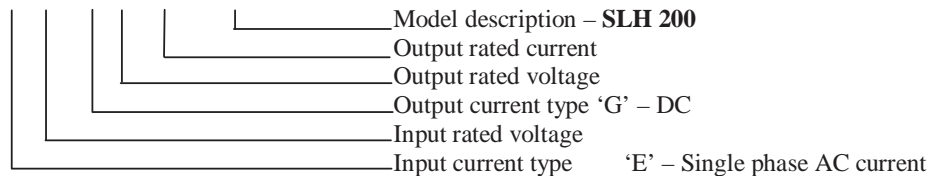

For the exact technical specifications refer to the data plate on the charger and the technical specifications attached.

3.3 Accessory Functional Description

3.3.1 Charger

Various battery connectors can be used depending on the battery type. The charger can therefore be supplied with or without a charging lead, as required. Refer to the attached delivery notes.

3.4 Residual Risk



Warning: Hazardous Electrical Voltage!

The charger is an electric component conducting voltages and currents that are hazardous to people.

The charger must therefore only be operated by trained technicians.

The charger must therefore only be opened, repaired and disassembled where necessary by qualified electrical engineers.

The mains supply and a battery contact where necessary must be disconnected before carrying out any work on the charger.



Explosion hazard

When a battery is charged, potentially explosive gases can escape.

The charger must therefore only be operated in well ventilated rooms.

Never remove the battery connection while charging. This could produce sparks which could ignite the charging gases (electrolytic gas).



Danger of getting caught on charging leads

A removed charging lead could cause people to trip over it and run the risk of interrupting a charge.

People can get caught on removed, loose cables, trip over them and pull the charging lead out of the battery during charging. The sparks this produces could ignite the charging gases and as a result cause a fire or trigger an explosion.

When connecting the battery always route the charging lead so that nobody can trip over it. After charging, place the charging lead carefully on its bracket.



Attention

Connecting an incorrect battery to the charger can result in damage to the charger and battery: The battery could gas, decoct or even explode.

Always check that the charger is set for your battery type. If in doubt, contact the relevant experts.



Attention

Corrosive acid gases can be produced when a battery is being charged. Acid gases can cause short circuits in electrical equipment (risk of burning) and can corrode components.

Therefore always position batteries next to charging stations in such a way that any acid gases arising can be freely distributed (reduced) on site and can dissipate.

3.5 Protective Mechanisms

The charger has been designed and constructed in accordance with state-of-the-art technology. If used properly, it therefore poses no danger to the health and safety of those operating it or third parties.

All live assemblies are fitted with housings and panels that can only be undone with tools. All cables and connectors are appropriately screened / earthed. The charger has an IP 21 protection class.

All electric and electronic components bear the CE mark; all necessary isolating distances have been observed. All circuits are fitted with primary and secondary fuses with defined current rating and activation characteristics.

All metallic components are earthed via an earth lead system.

The charger is fitted with an automatic cutout function as soon as the preset maximum charge status of the battery is reached. This avoids overloading and excessive release of explosive gases.

3.6 Charger Labelling and Decals

Baureihe Line	①	Typ Type	②
Serien-Nr. Serial-No.	③	Baujahr Year of manufacture	④
		Sicherung Fuse	⑤
Eingang Input	⑥		
Zellenzahl/Typ Number of cells/type	⑦	Schutzart Protection class	⑧
		Ausgang Output	⑨
Batteriekapazität Battery Capacity	⑩		
Hersteller Manufacturer Jungheinrich AG, D-22047 Hamburg, Germany			
CE		JUNGHEINRICH	

Data plate

Attached to the side of the housing.

Item	Description	Item	Description
1	Series	6	Input
2	Type	7	No. of cells/type
3	Serial no.	8	Protection class
4	Year of manufacture	9	Output
5	Fuse	10	Factory setting

 **Note Operating Instructions !**

T. Nr.: 756894 GB

- Ensure correct battery/charger type
- Ensure correct charging connector polarity
- Automatic delayed switch on ab. 5 sec.

 **Only qualified electrical personnel to open equipment**

48 V - 120 A

Operating instructions notice

Attached to the top of the housing cover.

Model performance plate

Attached to the front of the housing.
(Example: 48 volt / 120 amp)

4 Transport, Handling and Storage

The charger is supplied in a cardboard box.

Note the instructions on the cardboard box during transport, handling and storage.



Protect against the weather



Fragile



Top

5 Assembly / Installation / Commissioning

5.1 Delivery scope

The supply consists of the following (minimum) parts:

- Charger and preset charging program,
- the connected mains and battery cables,
- the operating instructions,
- a notice (attached to the charger),
- the delivery note.

Depending on the customer's requirements, the delivery scope and the charger version may deviate from this. The enclosed delivery papers (as well as the order confirmation) contain additional technical specifications.

- Check the delivery immediately to make sure it is complete and undamaged.
- Check the delivery note and the data plate to make sure they agree.

- If anything is missing contact the manufacturer and the shipping company immediately.
- Check the charger for any loose screw connections etc. If necessary, retighten these connections.

5.2 Site Requirements

Only use the charger in closed, frost-free and well ventilated rooms with ambient temperatures of up to 40°C. Select an assembly site where the ventilation slots will not be covered and the flow of cool air will not be affected. Do not assemble the charger near radiators or other sources of heat.

Naked flames and smoking in battery rooms are prohibited.

There must be no flammable materials or spark-producing liquids within a 2.5 metre radius of the charging station.

When assembling, note also that:

- no harmful gases, e.g. acid gases,
- no conductive dusts, such as soot or metallic dust,
- no excessive amounts of non-conductive dust and
- no fluids

may enter the inside of the charger.

When attaching the charger to the wall in an FWG 3 or FWG 6 housing, use the enclosed wall attachment material (4 off S10 dowels, 4 off M6x60 screws). The drilling plan is attached.

For chargers in the FDG 12 housing, make sure when assembling that there is sufficient ventilation, lateral clearance of at least 50cm to the next model and at least 30cm to any neighbouring walls.

It must be possible to connect to the mains and battery within a cable reach of 3m.

5.3 Mains Connection and Mains Fuses



Warning: Hazardous Electrical Voltage!

The charger is an electric component conducting voltages and currents that are hazardous to people.

The charger must therefore only be operated by trained technicians.

The charger must therefore only be opened, repaired and disassembled where necessary by qualified *electrical engineers*.

You will require a mains connection at the intended operation site to operate the charger. The mains voltage and frequency must match the specifications on the data plate. The mains connection must be properly earthed.

Protect the charger from excessive shock-hazard voltages in accordance with the local energy supplier's regulations.

- Arrange the mains fuses in series in accordance with the following table:

Rated current	Mains rating	Comment
0 to 6 A	6 A gL	gL safety fuses or safety devices with B or C characteristics can be used.
>6 to 10 A	10 A gL	
>10 to 16 A	16 A gL	
>16 to 18 A	20 A gL	
>18 to 23 A	25 A gL	
>23 to 32 A	35 A gL	

Table 1: Mains current and Mains Fuse Rating

5.4 Assembly and Installation

The following requirements must be met in order to assemble the charger:

a mains socket must be within reach,

there must be a surface next to the charger to place the battery on.

For exact details, refer to the technical specifications attached.

5.5 Commissioning the charger for the first time and operational testing

After assembling and installing the charger correctly, it must be commissioned for the first time for a functional test.

The charger is already factory-set. However, before using it for the first time, check that the charger is correctly set for the battery you wish to charge. For parameter checking, see Section 6.1.3.

After commissioning the charger for the first time, it must be labelled on the outside clearly, permanently and legibly with the details of the permissible battery type.

Attention



Connecting a non-authorized battery to the charger may result in material damage to the battery and charger, and consequently to the truck.

The owner and responsible service personnel must eliminate any possibility of confusion for the truck driver when connecting truck batteries.

- Note the respective battery type on the front of the housing – depending on the charging lead and the pre-set charging program installed.
- Also note any subsequent modifications to the charging program on the front of the housing.
- Also note if the actual rated current (I_n) is set to a lower value than the one indicated on the data plate.

6 Operation

Warning: Hazardous Electrical Voltage!



The charger is an electric component conducting voltages and currents that are hazardous to people.

The charger must therefore only be operated by trained technicians.

The charger must therefore only be opened, repaired and disassembled where necessary by qualified *electrical engineers*.

For a trained operator, battery charging generally includes the following stages:

- Check that the charger and battery type match,
- Connect the charger to the mains if necessary
- Connect the battery,
- (charging starts and ends automatically,)
- Disconnect the battery,

The following sections describe the various operating stages in more detail. Read them carefully before using the charger for the first time.

6.1 Operating and Display Function

The front of the charger contains the operating and display unit with the charge status light and the graphic display with soft keys:

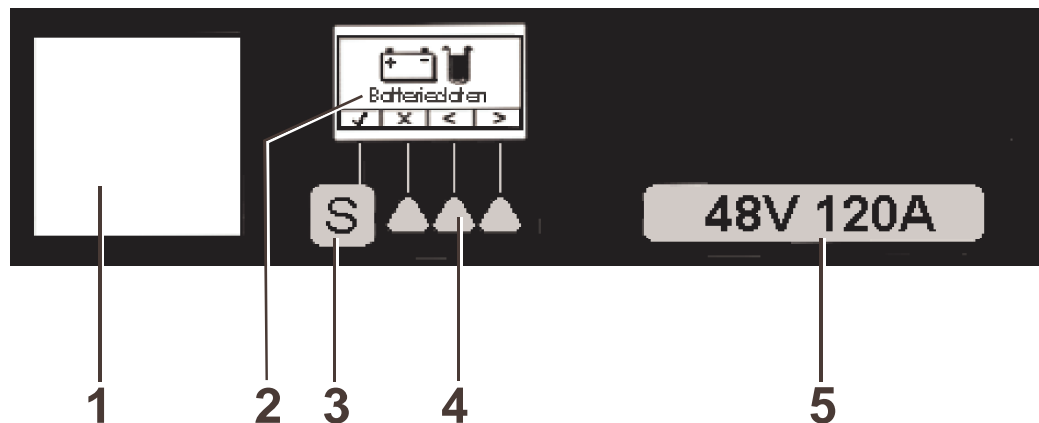

Figure 1: Operating and Display Field

- 1 Charge status light
 2 Graphic display
 3 Stop/Start switch – Soft key 1
 4 Soft keys 2 – 4
 5 Charger performance specification plate, e.g. 48 volts – 120 amps

6.1.1 Charge Status Light

The charge status light shows, in conjunction with the graphic display, the current operating status and the charging status.











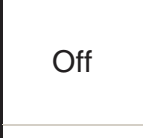

Colour	Meaning	Explanation
	Charge	Lights up during the (main) charging phase
	Charge	Lights up during the ährend der re-charging phase
	Charge end	Lights up when charging is complete
	Fault	Lights up if there is an equipment fault or incorrect operation: <ul style="list-style-type: none"> – Battery disconnected during charging – Power module faulty – Max. charging time or discharge rate exceeded – Overvoltage / low voltage cutout
	Ready	Charge status light out No charge, no error (e.g. display after system re-start or before using the charger for the first time)

Table 2: Charge Status Light

As well as the continually lit displays of the charge status light, some operating conditions are displayed as a flashing sequence of various colours (1 second rhythm). The following list shows the various flashing sequences and their meaning. As well as the flashing sequence, the graphic display shows the respective messages in text form.

Flashing sequence	Meaning	Explanation
 ► 	Charge start	Start of a new charging sequence
 ► 	Charge end/ fault	Charge complete / pump error or faulty power module
 ► 	Charge/fault	(Main) charge / pump error or faulty power module
 ► 	Charge/fault	Recharge / pump error or faulty power module

Flashing sequence	Meaning	Explanation
Orange ► Off	Charge break	Charge break (depends on set charging program)
Orange ► Red ► Off	Charge break / fault	Charge break / pump error or faulty power module
Yellow ► Green	Conservation charge	Conservation or compensation charge running
Red ► Yellow ► Green	Conservation charge / fault	Conservation or compensation charge / pump error or faulty power module

Table 3: Flashing sequences

6.1.2 Soft keys

There are four keys below the graphic display, known as the soft keys.



Figure 2: Soft keys

The layout and function of the various keys is shown as a symbol in the bottom line of the graphic display. The following table explains the significance of the symbols:

Symbol	Meaning	Explanation
During charge: Charging stopped ("S" key only)		
X	Cancel	In the menu control: Change from one menu level to the one below it (changes are not accepted)
During charge: Charging continues ("S" key only)		
✓	Confirm	In the menu control: Select the next highest menu level or confirm a changed setting
←	Cursor left	Controls the display cursor to the left
→	Cursor right	Controls the display cursor to the rights
↑	Cursor up / increase value	Controls the display cursor up, increases the value of the displayed setting
↓	Cursor down / decrease value	Controls the display cursor down, decreases the value of the displayed setting

Table 4: Soft key meaning

6.1.3 Graphic display and menu structure

The graphic display gives information on the charger and the charge status in symbol form and/or as text. The charger can be operated or changes made to the charger setting in conjunction with the soft keys below.

The following graphic shows the menu structure:

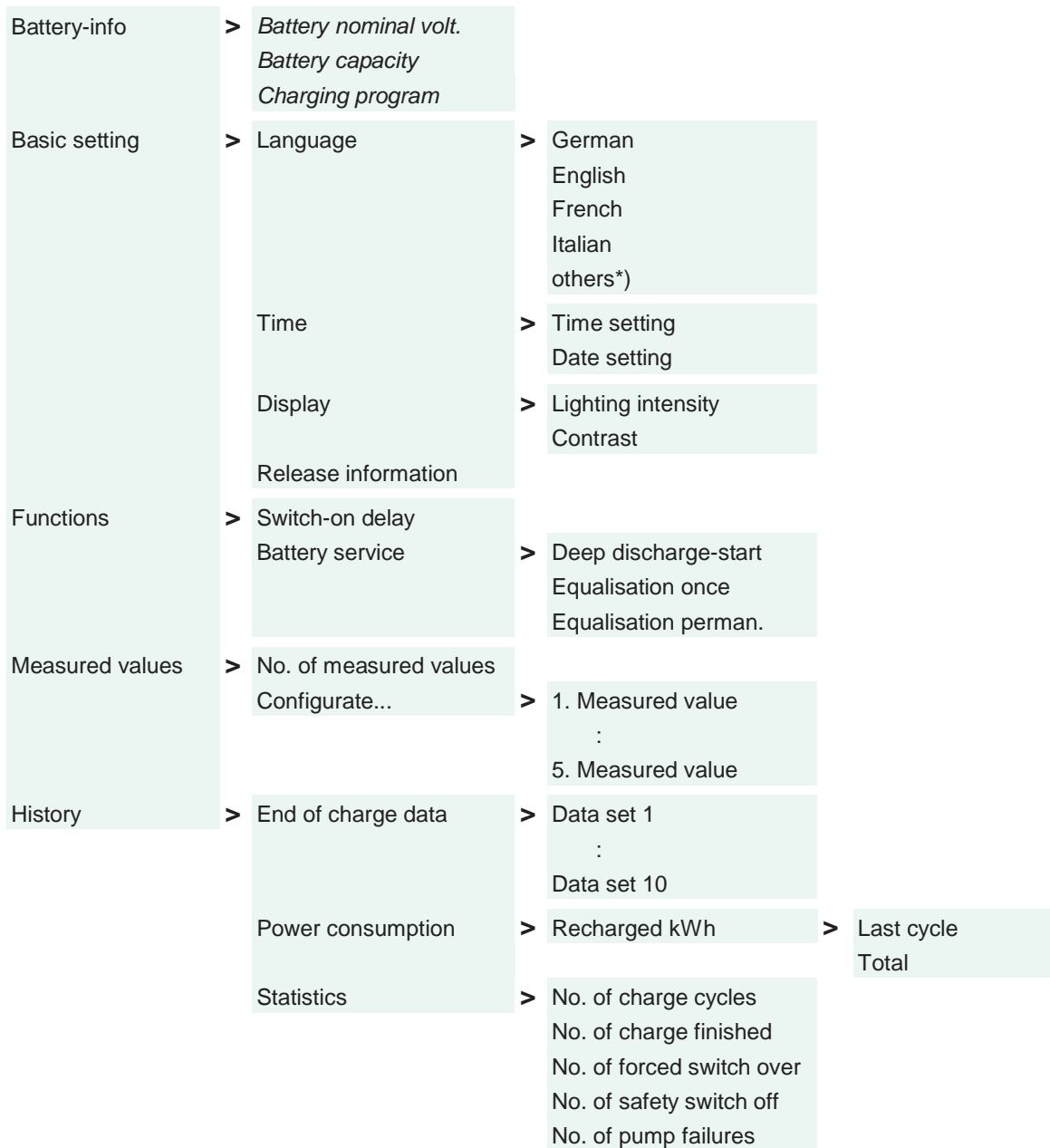

*) Indication only if an additional language has been loaded

Figure 3: Menu structure

6.1.4 Adjustable parameters

Settings can be made and parameter values changed within the menu. An overview of the various setting ranges and default values is given in the following table:

Menu item	Default value	Setting range
Language	<i>German</i>	German English French Italian others*
Time	<i>00:00</i>	00:00 - 23:59
Date	<i>01.01.2000</i>	01.01.2000 - 31.12.2099
Lightning intensity	<i>70 %</i>	0 - 100 %
Contrast	<i>100 %</i>	0 - 100 %
Switch-on delay	<i>0 Min.</i>	0 - 999 Min.
Battery service	--	Deep discharge-start Equalisation once Equalisation perman.
No. of measured values	<i>5</i>	1 – 5
1. Measured value .. 5. Measured value	<i>Charging voltage</i>	Charging voltage [V]
	<i>Charging current</i>	Charging current [A]
	<i>Charging voltage [V/Z]</i>	Charging voltage [V/Z]
	<i>Charging current [%]</i>	Charging current [%]
	<i>Charged Ah</i>	Charged Ah [Ah]
		Battery temperature [°C]
		Charging time [h]
		Date
		Time
		Status of modules

* * Indication only if an additional language has been loaded
Table 5: einstellbare Parameter

6.1.5 Function – Battery Maintenance

Deep discharge-start:

If the message “Check battery voltage” appears in the graphic display after the battery is connected, this means the battery voltage is insufficient to start charging. In this case a depletion start can be performed. Select the *Deep discharge start* function in menu item *Functions>Battery service* and confirm with *OK*. The charger starts in deep discharge start mode and charges until there is sufficient battery voltage to start normal charging.



Attention

Before activating depletion start, check that the charger is preset for the battery to be charged (voltage, capacity, type).

Equalisation once/perman.:

If a compensation charge is to be carried out after the normal charge, the equalisation charge function must be activated prior to charging. Select the *Equalisation once* function in menu item *Functions>Battery service* and confirm with *OK*. When the *Equalisation once* function is activated, a compensation charge is then carried out after the next charge. If the *Equalisation perman.* function is activated, a compensation charge is performed after every charge.

**Note**

The compensation charge starts 24 hours after the start of the normal charge. For some charging programs a compensation charge is included as standard. In this case the compensation charge cannot be activated.

6.1.6 Function – Measured values

The *Measured values* function allows you to set how many and which measured values are displayed in the graphic display during charging. See also Table 5.

6.1.7 Graphic Display Information

Information on the default settings of the charger and charging end data can also be taken from the graphic display, see following table:

Menu item	Information	Sample value
Battery-info	<i>Battery nominal volt.</i>	80V
	<i>Battery capacity</i>	200 Ah
	<i>Charging program</i>	LP2 (E)PzS
Basic setting	<i>Release information</i>	SLH 200
		V1.3 605676.03
History	<i>End of charge data</i>	Voltage: 2,7 V/Z
		Current: 10,2 A
		Charged Ah: 250,0 Ah
		Charging time: 08:00 h
		Time: 12:00
		Date: 01.07.2004
		Error messages
	<i>Power consumption</i>	Last cycle 20 kWh
		Total 100 kWh
		<i>Statistics</i>
	No. of charge cycles	
	No. of charge finished	
	No. of forced switch over	
	No. of safety switch off	
	No. of pump failures	

Table 6: Graphic Display Information

6.1.8 Parameters – Consumption data

The *History>Power consumption* menu item shows how many kWh were taken from the mains in the last charge and overall.

**Note**

The kWh meter is not calibrated and is therefore not permissible for accounting purposes.

6.1.9 Parameters - Statistics

The *History>Statistics* menu item allows the values of the internal event meter to be called up. They are as follows:

Display information	Explanation
No. of charge cycles	Number of charges started
No. of charge finished	Number of correctly completed charges
No. of forced switch over	Number of compulsory changes made
No. of safety switch off	Number of safety cut-outs due to charge time exceeded
No. of pump failures	Number of pump failures (pressure contact not applied)

6.2 Charger Mains Connection

The charger is fitted with a mains cable and lead for the power supply.

- Connect the charger to the mains circuit by inserting the connector in the socket.

The charger logo will then appear in the graphic display for approx. 3 seconds. The nominal data is then collated, and “Collect nominal data” appears in the graphic display. The charger then changes back to the standard display:

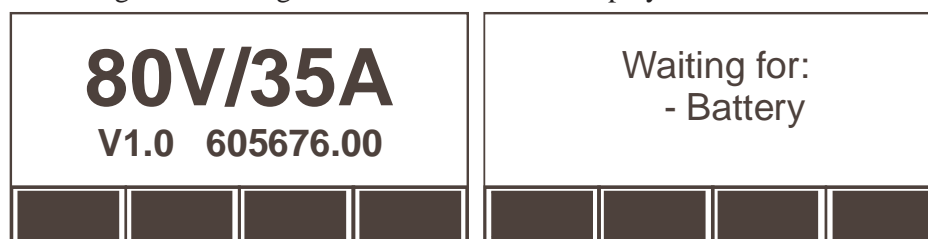

Figure 4: Standard alternating display (e.g. for an 80 volts / 35 amp charger)

6.3 Battery Connection**Danger**

The battery contains sulphuric acid which is highly corrosive. The floating metallic parts of a battery are always live. Do not open the battery housing and do not touch any non-insulated metal parts.

For this reason, work on batteries or battery systems must only be carried out:

- by trained personnel and
- with regard to the battery manufacturer's operating instructions.

Corrosive acid gases can be produced when a battery is being charged. Acid gases can cause short circuits in electrical equipment (risk of burning) and can corrode components.

- Therefore always position batteries next to charging stations in such a way that any acid gases arising can be freely distributed (reduced) on site and can dissipate.



Explosion hazard

Connecting an incorrect battery to the charger can result in damage to the charger and battery: The battery could gas, decoat or even explode.

Always check that the charger is set for your battery type. If in doubt, contact the relevant service department of the manufacturer.

We shall now describe how to connect the battery with a charging lead. Please note that charging automatically begins when the battery is connected.

Connect the battery as follows:

- Route the charging lead in such a way that nobody can trip over it and interrupt the charging.
- Connect the charging lead to the respective socket of the battery cable.

Automatic charging begins.

6.4 Charging automatic start

Charging starts automatically if

- the charger is connected to the mains,
- the battery terminals are connected correctly to the charger,
- the battery voltage is at least 1.6 volts/cell,
- the On/Off switch has not been pressed.

At the start of charging, the charger performs a self test. During this time the message “Start new charging” appears in the graphic display.



Figure 5: Charge start shown in graphic display

At the end of the starting process, the preset readings are cyclically shown in the graphic display. For reading details, refer to Section 6.7.

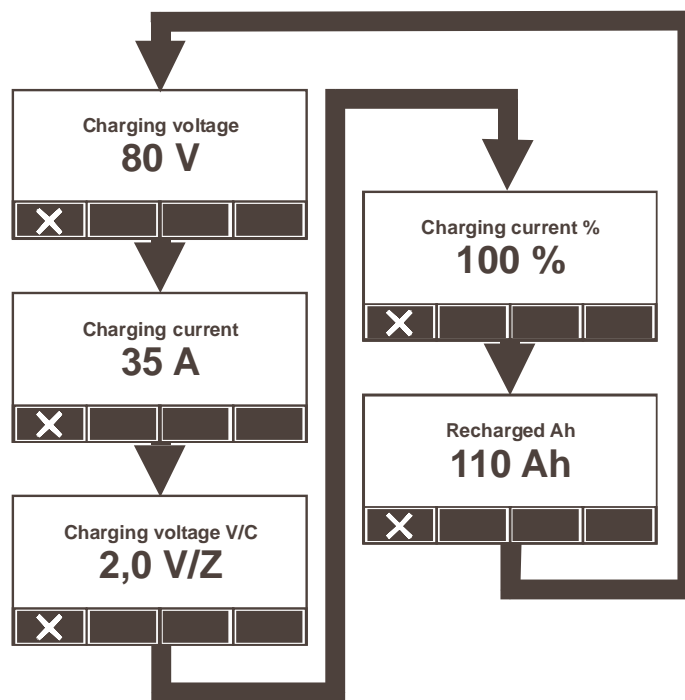

Figure 6: Standard reading display during charging

6.5 Interrupting a charge

The charger should not be interrupted during charging. However, external influences may necessitate interruption of the process. Note however:



Explosion hazard

Risk of serious damage to persons and property if the battery is disconnected during charging. The sparks produced could ignite gases which form during charging. Always press the 'S' key *first*, if you have to interrupt the charge. *Then* disconnect the charging lead from the battery.

Charging is interrupted when you press the 'S' key at the front of the panel (see also Section 6.1.2).

- Press the 'S' key once. The charging status light goes out.

Charging is continued when you press the 'S' key again.

- Press the 'S' key again. The charging status light is lit yellow or orange, depending on the charge status.



Note

In normal operation, charging should not end before the automatic cutout. Premature cutout will result in a depletion charge. This reduces the available battery capacity.

6.6 Charging automatic end

Charging automatically ends when the charging program is finished, i.e. the battery is fully charged. The charge status light is then lit green. You can now use the battery. The graphic display now shows "Charge over", alternating with the charge end voltage data (battery voltage in volts/cell), current (charge end current in A) and overall Ah (charged capacity in Ah).

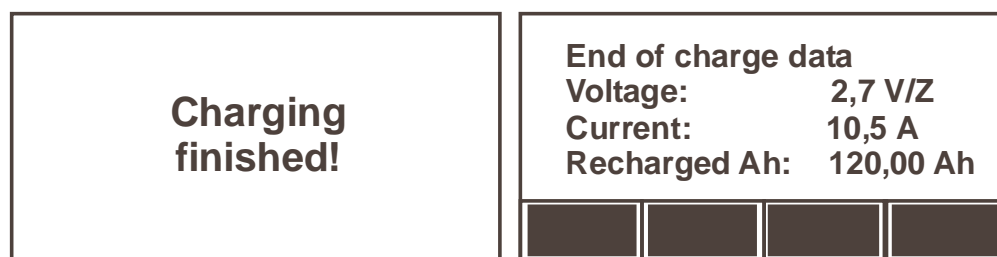

Figure 7: Alternating charge end display (RH picture: sample values)

6.7 Readings

As described in Section 6.1.4, certain readings can be displayed before, during and after the charge. The number of readings can be set from 1 to 5. For the various charger conditions the readings have the following significance:

Reading	Charger condition	Value displayed
Charge voltage*	<i>Charge, conservation charge</i>	Charge voltage
	<i>Recharge interval</i>	Battery voltage
	<i>Charge end, conservation charge interval</i>	Charge end voltage
Charge current*	<i>Charge, recharge interval, conservation charge</i>	Charge current
	<i>Charge end, conservation charge interval</i>	Charge end current
Charge voltage [V/C]	<i>Charge, conservation charge</i>	Charge voltage [V/C]
	<i>Recharge interval</i>	Battery voltage [V/C]
	<i>Charge end, conservation charge interval</i>	Charge end voltage [V/C]
Charge current % (of charge rated current)	<i>Charge, recharge interval, conservation charge</i>	Charge current [%]
	<i>Conservation charge interval</i>	Charge end current %
Ah total*	<i>Charge, recharge interval</i>	Current Ah total
	<i>Charge end, conservation charge interval</i>	Charge end Ah total
Battery temperature	<i>Charge, recharge interval, conservation charge</i>	Current temperature
	<i>Charge end, conservation charge interval</i>	Charge end temperature
Charge time*	<i>Charge, recharge interval, conservation charge</i>	Current charge time
	<i>Charge end, conservation charge interval</i>	Overall charge time
Date	<i>Charge, recharge interval, conservation charge</i>	Current date
	<i>Charge end, conservation charge interval</i>	Charge end date
Time*	<i>Charge, recharge interval, conservation charge</i>	Current time
	<i>Charge end, conservation charge interval</i>	Charge end time
Module status	<i>All charging phases</i>	Decimal value, display for charger service only

*Default values

6.8 Status messages

Status messages are shown via the graphic display and some are also shown via the charge status light.













Graphic display message	Charge Status Light	Cause	Effect
Charge complete <i>alternating with</i> Charge end data voltage: ... V/C current: ... A Ah total: ... Ah		Charging completed properly.	
Charge ended by user		Charging cancelled prematurely by user	Battery not fully charged
Battery disconnected during charging		Battery disconnected without pressing the 'S' key	Operating error! See 6.5 Battery not fully charged
Compulsory change Re-charge!	 Display during charge	The max. permissible main charge time has been exceeded.	Safety function! See also section 6.9
Mains failure	 Display during mains failure	Mains failure	Charge time is extended!

Table 7: Status messages

6.9 Faults and Error Messages

The charger reports faults via the graphic display and the charging status light. The following table gives an overview of the various fault causes and how to rectify them.

Graphic display message	Charge Status Light	Cause	Remedy
Max. charge time exceeded Charge complete Max. charge capacity exceeded Charge complete		The max. permissible charge time has been exceeded. The max. permissible charge capacity has been exceeded.	Safety cutout Battery capacity too great for charger Battery faulty Notify battery service department
Deviation I max! Charge complete		Too much current from power part. Control system damaged.	Charger error Notify service department
Battery disconnected during charging		Battery disconnected without pressing the 'S' key.	Operating error Press 'S' key before disconnecting the battery, see 6.5. Check charging lead contacts.
Compulsory change Re-charge!	Display works normally	The max. permissible main charge time has been exceeded.	Safety function! Battery capacity too great for charger Notify battery service department
Mains failure Mains disconnected	 Display during mains failure	Mains failure Mains fuse faulty	Check / replace mains fuse
Deviation I min!	Display works normally	Charge current less than controller specification	Notify service department Note: the charger does not cut out.
Overvoltage cutout Overvoltage Check battery voltage		Output voltage greater than 3.0 volts/cell	Notify service department
Low voltage cutout Low voltage Check battery voltage		Output voltage less than minimum cell voltage..	Wrong battery connected. Battery depleted. Activate depletion charge start. Notify battery service department
Module failure Module failure 1,2...n	 Display flashes alternately with current charge status, see 6.1.1.	Power module failure	Notify service department



Graphic display message	Charge Status Light	Cause	Remedy
Pump error Pressure drop	Display flashes alternately with current charge status, see 6.1.1.	Pressure switch on pump does not close.	
Overtemperature Temperature error.		Power part overtemperature.	Check ventilation slots. Allow the power part to cool. Notify service department
			

Table 8: Faults and Error Messages

6.10 Switching off the charger

The charger is energised via the mains cable. Disconnect the charger from the mains if:

- the charger is not permanently required,
- the charger electronic system is to be reset to the start status (reset), e.g. if a fault is displayed.

7 Maintenance



Warning: Hazardous Electrical Voltage!

The charger is an electric component conducting voltages and currents that are hazardous to people.

The charger must therefore only be installed, opened, repaired and disassembled where necessary by qualified electrical engineers.

The mains supply and a battery contact where necessary must be disconnected before carrying out any work on the charger.

7.1 Cleaning, Inspection and Maintenance

The charger is maintenance-free and will operate trouble-free if used correctly.

- Dust or dirt on the charger can be removed with a dry cloth.

Check at least monthly that

- the mains connection is undamaged,
- the housing is undamaged,
- the charging lead insulation is undamaged,
- the charging lead plug is undamaged,
- the additional earth conductor in three-phase devices is undamaged
- all screw connections are tight.

If any faults are detected, immediately put the charger out of service; all faults must be immediately rectified by specialist technicians.

If the housing has to be opened for maintenance and repairs, contact the charger manufacturer.

7.2 Changing the charging program

The charging program is factory set (see Appendix). If the charging program has to be changed, please contact the manufacturer.

7.3 Spare parts

Should you require spare parts, contact the manufacturer, stating the charger data contained on the data plate.

8 Disposal

If the charger is to be finally decommissioned, all relevant laws and regulations concerning disposal at the time must be adhered to.

For further information contact the specialist disposal companies or the local authorities.



Attention

Electronic waste contains a wide range of plastic, metal and heavy metal components which pose a high hazard risk to the environment. Electronic waste should therefore be collected and disposed of separately from household or trade waste.

Electronic waste must be dealt with by your company's disposal department who will arrange to have it removed by special disposal companies.

Dispose of the charger's packaging separately. Paper, cardboard and plastic should be recycled.

9 Appendix

9.1 Dimension and Projection Drawings (not to scale)

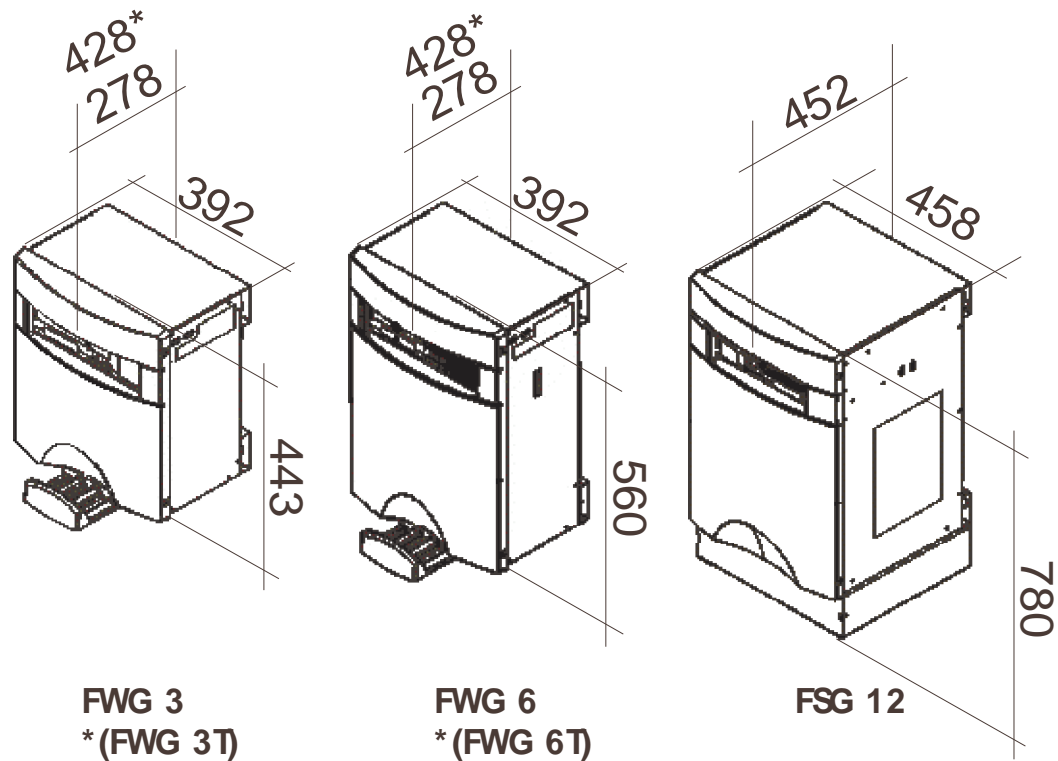

Figure 8: Dimension drawings (*housing depth for T version)

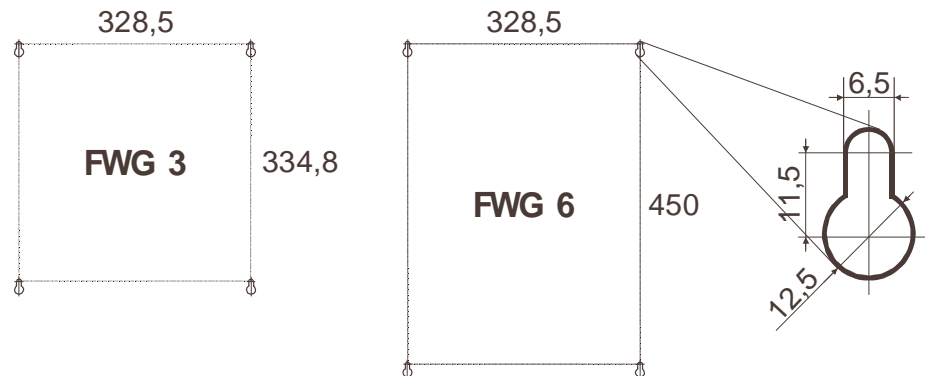

Figure 9: Drill diagrams

Housing type	Dimensions (mm)		
	Height	Width	Depth
FWG 3	443	392	278
FWG 3 T	443	392	428
FWG 6	560	392	278
FWG 6 T	560	392	428
FSG 12	780	458	452
S 22	1093	553	410

Table 9: Dimensions

9.2 Specifications

Series	SLH 200
Model no.	See data plate
Battery type	Wet cell or maintenance-free battery
Characteristic curve	See section 6.4.1
Temperature range	0 to 40 °C
Input rated frequency	47.5 – 63 Hz
Protection class	IP 21 in accordance with EN 60529
Housing	See appendix 'Dimension and Projection Drawings'
Standards	73/23/EWG – Low voltage guideline 89/336/EWG – EMC guideline EN 60335-2-29 – Safety EN 61558 – Transformers EN 60146 – Semi-conductor power converters EN 61000-6-2 and EN 61000-6-3 – EMC EN 61000-3-2 – Mains feedback EN 61000-3-3 – Voltage fluctuations and flickering EN 61000-4-4 – Burst and surge

9.3 Model table

The charger model can be clearly identified from the model description in the data plate.

Out-put-voltage	Model type	Housing	Weight	Out put current	Mains current	Mains voltage	Min. mains fuse	Mains cable	Mains plug	Charge cable	power consumption
[V]			[kg]	[A]	[A]	[V]	[A]	[mm ²]		[mm ²]	kVA
24	E230 G 24/ 20 B-SLH200	FWG 3*)	22	20	2,3	230	6	3 x 1,5	Schuko	16	0,5
	E230 G 24/ 25 B-SLH200	FWG 3*)	22	25	3	230	6	3 x 1,5	Schuko	16	0,7
	E230 G 24/ 35 B-SLH200	FWG 3*)	22	35	4	230	6	3 x 1,5	Schuko	16	0,9
	E230 G 24/ 50 B-SLH200	FWG 3*)	22	50	6	230	6	3 x 1,5	Schuko	16	1,4
	E230 G 24/ 65 B-SLH200	FWG 3*)	22	65	8	230	10	3 x 1,5	Schuko	16	1,8
	E230 G 24/ 85 B-SLH200	FWG 3*)	22	85	10	230	16	3 x 1,5	Schuko	16	2,3
	E230 G 24/100 B-SLH200	FWG 3*)	22	100	12	230	16	3 x 1,5	Schuko	25	2,8
	E230 G 24/120 B-SLH200	FWG 3*)	22	120	14	230	16	3 x 1,5	Schuko	25	3,2
	D400 G 24/150 B-SLH200	FWG 6*)	36	150	6,5	3 x 400	10	5 x 2,5	CEE 16	35	4,5
D400 G 24/170 B-SLH200	FWG 6*)	36	170	7,5	3 x 400	10	5 x 2,5	CEE 16	50	5,2	
D400 G 24/190 B-SLH200	S 22	61	190	11	3 x 400	16	5 x 2,5	CEE 16	50	7,6	
48	E230 G 48/ 35 B-SLH200	FWG 3*)	22	35	8	230	10	3 x 1,5	Schuko	16	1,8
	E230 G 48/ 50 B-SLH200	FWG 3*)	22	50	11,6	230	16	3 x 1,5	Schuko	16	2,7
	E230 G 48/ 65 B-SLH200	FWG 3*)	22	65	15	230	16	3 x 1,5	Schuko	16	3,5
	D400 G 48/ 85 B-SLH200	FWG 6*)	36	85	7,5	3 x 400	10	5 x 2,5	CEE 16	16	5,2
	D400 G 48/100 B-SLH200	FWG 6*)	36	100	8,8	3 x 400	10	5 x 2,5	CEE 16	25	6,1
	D400 G 48/120 B-SLH200	FWG 6*)	36	120	10,3	3 x 400	16	5 x 2,5	CEE 16	25	7,1
	D400 G 48/150 B-SLH200	FSG 12	71	150	12,5	3 x 400	16	5 x 2,5	CEE 16	35	8,6
D400 G 48/170 B-SLH200	FSG 12	71	170	14,5	3 x 400	16	5 x 2,5	CEE 16	50	10,0	
80	D400 G 80/ 50 B-SLH200	FWG 6*)	36	50	7,8	3 x 400	10	5 x 2,5	CEE 16	16	5,4
	D400 G 80/ 65 B-SLH200	FWG 6*)	36	65	9,6	3 x 400	16	5 x 2,5	CEE 16	16	6,6
	D400 G 80/ 85 B-SLH200	FWG 6*)	36	85	12	3 x 400	16	5 x 2,5	CEE 16	16	8,3
	D400 G 80/100 B-SLH200	FSG 12	71	100	14,3	3 x 400	16	5 x 2,5	CEE 16	25	9,9
	D400 G 80/120 B-SLH200	FSG 12	71	120	17	3 x 400	20	5 x 2,5	CEE 32	25	11,7
	D400 G 80/150 B-SLH200	FSG 12	71	150	21	3 x 400	25	5 x 4	CEE 32	35	14,5
D400 G 80/170 B-SLH200	S 22	96	170	25	3 x 400	35	5 x 6	CEE 32	50	17,3	

*) FWG 3T bzw. FWG 6T bei Option Spezialfilter

Table 10: Model table

9.4 Charging programs

The charging program (CP) is factory set. If the charging program has to be changed, please contact the manufacturer. If, when you connect the battery the graphic display shows “No CP set”, there is no valid charging program and no battery capacity preset. In this case you should contact the manufacturer.

DC volt.	Charge program:	(E)PzS LP 2			(E)PzS Puls LP 3	(E)PzV LP 4	WF 200 plus LP 5	WF 200 plus LP5	Champion LP 7	Evolution LP 8
		Charge time without EC (*)			7 - 8,5h Cap. (Ah)	12 - 14h Cap. (Ah)	8 - 10h Cap. (Ah)	10 - 12h Cap. (Ah)	12h Cap. (Ah)	12 - 14h Cap. (Ah)
[V]	Charger type	7 - 8,5h Cap. (Ah)	9 - 11,5h Cap. (Ah)	12 - 14h Cap. (Ah)	7 - 8,5h Cap. (Ah)	12 - 14h Cap. (Ah)	8 - 10h Cap. (Ah)	10 - 12h Cap. (Ah)	12h Cap. (Ah)	12 - 14h Cap. (Ah)
24	E 230 G 24/ 20 B-SLH200	90 - 120	130 - 150	170 - 220	110 - 140	120 - 150	80 - 110	110 - 130	130 - 170	90 - 120
	E 230 G 24/ 25 B-SLH200	110 - 150	160 - 190	210 - 280	140 - 190	150 - 185	100 - 140	140 - 170	160 - 210	110 - 150
	E 230 G 24/ 35 B-SLH200	150 - 210	220 - 270	290 - 390	190 - 260	190 - 260	140 - 195	195 - 230	225 - 290	150 - 210
	E 230 G 24/ 50 B-SLH200	210 - 290	310 - 390	420 - 560	260 - 360	270 - 370	200 - 280	280 - 330	320 - 420	210 - 300
	E 230 G 24/ 65 B-SLH200	300 - 380	410 - 500	540 - 720	350 - 460	380 - 480	260 - 360	360 - 430	420 - 540	300 - 380
	E 230 G 24/ 85 B-SLH200	390 - 500	530 - 650	710 - 940	460 - 610	490 - 630	340 - 470	470 - 560	550 - 710	380 - 500
	E 230 G 24/100 B-SLH200	460 - 590	630 - 770	830 - 1110	540 - 710	605 - 740	400 - 560	560 - 670	645 - 830	450 - 580
	E 230 G 24/120 B-SLH200	550 - 710	750 - 920	1000 - 1330	650 - 860	730 - 890	480 - 675	675 - 800	775 - 1200	540 - 700
	D 400 G 24/150 B-SLH200	680 - 880	940 - 1150	-	810 - 1070	900 - 1110	600 - 840	840 - 1000	970 - 1250	680 - 880
	D 400 G 24/170 B-SLH200	770 - 1000	1060 - 1310	-	920 - 1210	1030 - 1260	680 - 940	940 - 1130	1095 - 1420	775 - 1000
D 400 G 24/190 B-SLH200	860 - 1120	-	-	1030 - 1360	-	750 - 1050	1050 - 1270	1225 - 1580	-	
48	E 230 G 48/ 35 B-SLH200	150 - 210	220 - 270	290 - 390	190 - 260	190 - 260	140 - 195	195 - 230	225 - 290	150 - 210
	E 230 G 48/ 50 B-SLH200	210 - 290	310 - 390	420 - 560	260 - 360	270 - 370	200 - 280	280 - 330	320 - 420	210 - 300
	E 230 G 48/ 65 B-SLH200	300 - 380	410 - 500	540 - 720	350 - 460	380 - 480	260 - 360	360 - 430	420 - 540	300 - 380
	D 400 G 48/ 85 B-SLH200	390 - 500	530 - 650	710 - 940	460 - 610	490 - 630	340 - 470	470 - 560	550 - 710	380 - 500
	D 400 G 48/100 B-SLH200	460 - 590	630 - 770	830 - 1110	540 - 710	605 - 740	400 - 560	560 - 670	645 - 830	450 - 580
	D 400 G 48/120 B-SLH200	550 - 710	750 - 920	1000 - 1330	650 - 860	730 - 890	480 - 675	675 - 800	775 - 1200	540 - 700
	D 400 G 48/150 B-SLH200	680 - 880	940 - 1150	-	810 - 1070	900 - 1110	600 - 840	840 - 1000	970 - 1250	680 - 880
	D 400 G 48/170 B-SLH200	770 - 1000	1060 - 1310	-	920 - 1210	1030 - 1260	680 - 940	940 - 1130	1095 - 1420	775 - 1000
80	D 400 G 80/ 50 B-SLH200	210 - 290	310 - 390	420 - 560	260 - 360	(**)	200 - 280	280 - 330	320 - 420	(**)
	D 400 G 80/ 65 B-SLH200	300 - 380	410 - 500	540 - 720	350 - 460	(**)	260 - 360	360 - 430	420 - 540	(**)
	D 400 G 80/ 85 B-SLH200	390 - 500	530 - 650	710 - 940	460 - 610	(**)	340 - 470	470 - 560	550 - 710	(**)
	D 400 G 80/100 B-SLH200	460 - 590	630 - 770	830 - 1110	540 - 710	(**)	400 - 560	560 - 670	645 - 830	(**)
	D 400 G 80/120 B-SLH200	550 - 710	750 - 920	1000 - 1330	650 - 860	(**)	480 - 675	675 - 800	775 - 1200	(**)
	D 400 G 80/150 B-SLH200	680 - 880	940 - 1150	-	810 - 1070	(**)	600 - 840	840 - 1000	970 - 1250	(**)
	D 400 G 80/170 B-SLH200	770 - 1000	1060 - 1310	-	920 - 1210	(**)	680 - 940	940 - 1130	1095 - 1420	(**)

(*) 1.5h less recharge time with EC

(**) Higher battery capacities and 80 V applications on request.

Table 11: Charging programs

9.5 Spare parts catalog